



Przedsiębiorstwo Produkcyjno Handlowo Usługowe

ReBaNo

Renata i Bartosz Nowaczy

ul. Kopanina 39, 60-105 Poznań

tel./faks: +48 61 657-93-65, e-mail: biuro@rebano.pl

NIP: 779-103-65-86, REGON: 630603794

Rok założenia 1996



DEKA
controls

12 Filtry hermetyczne cieczowe osuszające – 46 bar / 31 bar

Model	przyłącze		typ	cena cennikowa	
	wielkość			45 bar HCFC, HFC, CO ₂	31 bar gazy palne HC (F1)
D.-052	1/4 "	6 mm	skręcane	8,64 EUR	10,24 EUR
D.-052S	1/4 "		lutowane	8,64 EUR	10,24 EUR
D.-056S		6 mm	lutowane	8,64 EUR	10,24 EUR
D.-053	3/8 "	10 mm	skręcane	8,64 EUR	10,24 EUR
D.-053S	3/8 "		lutowane	8,64 EUR	10,24 EUR
D.-0510S		10 mm	lutowane	8,64 EUR	-
D.-082	1/4 "	6 mm	skręcane	11,52 EUR	13,12 EUR
D.-082S	1/4 "		lutowane	11,52 EUR	13,12 EUR
D.-086S		6 mm	lutowane	11,52 EUR	13,12 EUR
D.-083	3/8 "	10 mm	skręcane	11,52 EUR	13,12 EUR
D.-083S	3/8 "		lutowane	11,52 EUR	13,12 EUR
D.-0810S		10 mm	lutowane	11,52 EUR	13,12 EUR
D.-084	1/2 "	12 mm	skręcane	11,52 EUR	13,12 EUR
D.-084S	1/2 "		lutowane	11,52 EUR	13,12 EUR
D.-0812S		12 mm	lutowane	11,52 EUR	13,12 EUR
D.-162	1/4 "	6 mm	skręcane	15,36 EUR	17,20 EUR
D.-163	3/8 "	10 mm	skręcane	15,36 EUR	17,20 EUR
D.-163S	3/8 "		lutowane	15,36 EUR	17,20 EUR
D.-1610S		10 mm	lutowane	15,36 EUR	17,20 EUR
D.-164	1/2 "	12 mm	skręcane	15,36 EUR	17,20 EUR
D.-164S	1/2 "		lutowane	15,36 EUR	17,20 EUR
D.-1612S		12 mm	lutowane	15,36 EUR	17,20 EUR
D.-165	5/8 "	16 mm	skręcane	15,36 EUR	17,20 EUR
D.-165S	5/8 "	16 mm	lutowane	15,36 EUR	17,20 EUR
D.-303	3/8 "	10 mm	skręcane	26,40 EUR	29,12 EUR
D.-303S	3/8 "		lutowane	26,40 EUR	29,12 EUR
D.-304	1/2 "	12 mm	skręcane	26,40 EUR	29,12 EUR
D.-304S	1/2 "		lutowane	26,40 EUR	29,12 EUR
D.-3012S		12 mm	lutowane	26,40 EUR	29,12 EUR
D.-305	5/8 "	16 mm	skręcane	26,40 EUR	29,12 EUR
D.-305S	5/8 "	16 mm	lutowane	26,40 EUR	29,12 EUR
D.-307S	7/8 "	22 mm	lutowane	35,20 EUR	37,92 EUR



Filtry dwustronne (dwukierunkowe) hermetyczne cieczowe osuszające – 46 bar

Model	przyłącze		typ	cena cennikowa HCFC, HFC, CO ₂
	wielkość			
DB-082	1/4 "	6 mm	skręcane	19,60 EUR
DB-082S	1/4 "		lutowane	19,60 EUR
DB-086S		6 mm	lutowane	19,60 EUR
DB-083	3/8 "		skręcane	19,60 EUR
DB-083S	3/8 "		lutowane	19,60 EUR
DB-0810S		10 mm	lutowane	19,60 EUR
DB-084	1/2 "		skręcane	19,60 EUR
DB-084S	1/2 "		lutowane	19,60 EUR
DB-0812S		12 mm	lutowane	19,60 EUR
DB-162	1/4 "	6 mm	skręcane	24,48 EUR
DB-163	3/8 "	10 mm	skręcane	24,48 EUR
DB-163S	3/8 "		lutowane	24,48 EUR
DB-1610S		10 mm	lutowane	24,48 EUR
DB-164	1/2 "	12 mm	skręcane	24,48 EUR
DB-164S	1/2 "		lutowane	24,48 EUR
DB-1612S		12 mm	lutowane	24,48 EUR
DB-165	5/8 "	16 mm	skręcane	24,48 EUR
DB-165S	5/8 "	16 mm	lutowane	24,48 EUR
DB-303	3/8 "	10 mm	skręcane	48,96 EUR
DB-304	1/2 "	12 mm	skręcane	48,96 EUR
DB-304S	1/2 "		lutowane	48,96 EUR
DB-3012S		12 mm	lutowane	48,96 EUR
DB-305	5/8 "	16 mm	skręcane	48,96 EUR
DB-305S	5/8 "	16 mm	lutowane	48,96 EUR
DB-307S	7/8 "	22 mm	lutowane	48,96 EUR





Przedsiębiorstwo Produkcyjno Handlowo Usługowe
ReBaNo
 Renata i Bartosz Nowaczy
 ul. Kopanina 39, 60-105 Poznań
 tel./faks: +48 61 657-93-65, e-mail: biuro@rebano.pl
 NIP: 779-103-65-86, REGON: 630603794
 Rok założenia 1996



DEKA
 controls

Obudowy filtrów z wymiennym wkładem – 45 bar / 31 bar

Model	przyłącze		ilość wkładów	cena cennikowa		
	wielkość	typ		45 bar HCFC, HFC, CO ₂	31 bar gazy palne HC (F1)	
DS.-485	5/8 "	16 mm	lutowane	1	79,84 EUR	92,80 EUR
DS.-487	7/8 "	22 mm	lutowane	1	79,84 EUR	92,80 EUR
DS.-489	1.1/8 "	28 mm	lutowane	1	81,20 EUR	94,40 EUR
DS.-4811	1.3/8 "	35 mm	lutowane	1	85,44 EUR	99,20 EUR
DS.-4813	1.5/8 "	42 mm	lutowane	1	88,24 EUR	102,40 EUR
DS.-4817	2.1/8 "	54 mm	lutowane	1	91,04 EUR	105,60 EUR
DS.-4864	2.1/2 "	64 mm	lutowane	1	107,84 EUR	122,80 EUR
DS.-4876	3 "	76 mm	lutowane	1	118,72 EUR	134,48 EUR
DS.-4880	3.1/8 "	80 mm	lutowane	1	118,72 EUR	134,48 EUR
DS.-967	7/8 "	22 mm	lutowane	2	105,04 EUR	121,44 EUR
DS.-969	1.1/8 "	28 mm	lutowane	2	105,04 EUR	121,44 EUR
DS.-9611	1.3/8 "	35 mm	lutowane	2	105,04 EUR	121,44 EUR
DS.-9613	1.5/8 "	42 mm	lutowane	2	109,20 EUR	126,40 EUR
DS.-9617	2.1/8 "	54 mm	lutowane	2	109,20 EUR	126,40 EUR
DS.-1449	1.1/8 "	28 mm	lutowane	3	127,44 EUR	145,44 EUR
DS.-14411	1.3/8 "	35 mm	lutowane	3	131,60 EUR	150,40 EUR
DS.-14413	1.5/8 "	42 mm	lutowane	3	131,60 EUR	150,40 EUR
DS.-14417	2.1/8 "	54 mm	lutowane	3	137,20 EUR	159,20 EUR
DS.-19211	1.3/8 "	35 mm	lutowane	4	149,84 EUR	170,24 EUR
DS.-19213	1.5/8 "	42 mm	lutowane	4	156,80 EUR	177,60 EUR
DS.-19217	2.1/8 "	54 mm	lutowane	4	158,24 EUR	179,44 EUR
DS.-19221	2.5/8 "	-	lutowane	4	210,00 EUR	231,60 EUR
DS.-19225	-	80 mm	lutowane	4	210,00 EUR	231,60 EUR



Obudowy filtrów z wymiennym wkładem do CO2 zastosowanie podkrytyczne – 55 bar

Model	przyłącze		ilość wkładów	cena cennikowa	
	wielkość	typ			
DSH-487*	-	22 mm	lutowane	1	125,60 EUR

*inne rozmiary obudowy na zapytanie

Wymienne wkłady do obudów filtrów

Symbol	uszczelki	opis	czynnik	cena cennikowa
T-48	brak	osuszający	HCFC, HFC, HC, CO ₂	15,92 EUR
T-48-S1	w zestawie	osuszający	HCFC, HFC, HC, CO ₂	19,20 EUR
W-48	brak	odkwaszający	HCFC, HFC, HC, CO ₂	23,68 EUR
W-48-S1	w zestawie	odkwaszający	HCFC, HFC, HC, CO ₂	31,68 EUR
F-48	-	ssawny mechaniczny	HCFC, HFC, HC, CO ₂	26,00 EUR





Przedsiębiorstwo Produkcyjno Handlowo Usługowe
ReBaNo
 Renata i Bartosz Nowaczy
 ul. Kopanina 39, 60-105 Poznań
 tel./faks: +48 61 657-93-65, e-mail: biuro@rebano.pl
 NIP: 779-103-65-86, REGON: 630603794
 Rok założenia 1996



DEKA
 controls

Wzierniki przepływu i zawilgocenia układu

Model	przyłącze		typ	cena cennikowa	
	wielkość			HCFC, HFC, CO ₂ 45 bar (V)	CO ₂ 60 bar (S)
V(S)IB-014	1/4 "	-	lutowane	20,40 EUR	na życzenie
V(S)IB-006	-	6 mm	lutowane	21,44 EUR	na życzenie
V(S)IB-038	3/8 "	-	lutowane	20,40 EUR	na życzenie
V(S)IB-010	-	10 mm	lutowane	21,44 EUR	na życzenie
V(S)IB-012	1/2 "	-	lutowane	21,44 EUR	na życzenie
V(S)IB-012m	-	12 mm	lutowane	21,44 EUR	na życzenie
V(S)IB-016	5/8 "	16 mm	lutowane	22,32 EUR	na życzenie
V(S)IB-018	-	18 mm	lutowane	22,64 EUR	na życzenie
V(S)IB-022	7/8 "	22 mm	lutowane	25,12 EUR	na życzenie
V(S)IB-118	1.1/8 "	-	lutowane	25,36 EUR	na życzenie
V(S)IB-028	-	28 mm	lutowane	25,36 EUR	na życzenie
V(S)IS-012	1/4 "	6 mm	skręcane	21,12 EUR	na życzenie
V(S)IS-014	3/8 "	10 mm	skręcane	20,68 EUR	na życzenie
V(S)IS-038	1/2 "	12 mm	skręcane	20,56 EUR	na życzenie
V(S)IS-058	5/8 "	16 mm	skręcane	24,16 EUR	na życzenie

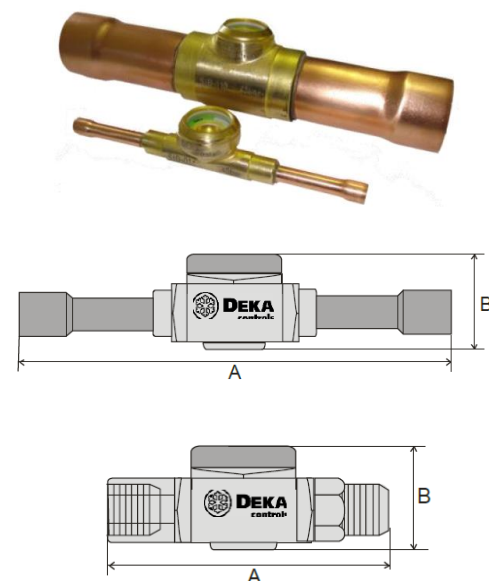

Zawory odcinające kulowe

Model	przyłącze		typ	cena cennikowa				
	wielkość			gazy palne HC, HFC, CFC 31 bar (F1)		HCFC, HFC, CO ₂ - 45 bar		CO ₂ - 120 bar bez AVX (H)
				bez AVX (F1)	z AVX (S-F1)	bez AVX	z AVX (S)	
DBV.-014	1/4 "	-	lutowane	20,16 EUR	-	20,16 EUR	-	26,20 EUR
DBV.-006	-	6 mm	lutowane	20,16 EUR	-	20,16 EUR	-	26,20 EUR
DBV.-038	3/8 "	-	lutowane	19,36 EUR	23,92 EUR	19,36 EUR	23,92 EUR	30,40 EUR
DBV.-010	-	10 mm	lutowane	19,36 EUR	23,92 EUR	19,36 EUR	23,92 EUR	15,20 EUR
DBV.-012	1/2 "	-	lutowane	19,60 EUR	24,16 EUR	19,60 EUR	24,16 EUR	31,60 EUR
DBV.-012M	-	12 mm	lutowane	19,60 EUR	24,16 EUR	19,60 EUR	24,16 EUR	15,80 EUR
DBV.-015	-	15 mm	lutowane	24,64 EUR	29,20 EUR	24,64 EUR	29,20 EUR	na życzenie
DBV.-016	5/8 "	16 mm	lutowane	25,20 EUR	29,76 EUR	25,20 EUR	29,76 EUR	34,80 EUR
DBV.-018	-	18 mm	lutowane	28,56 EUR	33,12 EUR	28,56 EUR	33,12 EUR	51,00 EUR
DBV.-022	7/8 "	22 mm	lutowane	35,84 EUR	40,40 EUR	35,84 EUR	40,40 EUR	62,20 EUR
DBV.-118	1.1/8 "	-	lutowane	49,04 EUR	53,60 EUR	49,04 EUR	53,60 EUR	89,80 EUR
DBV.-028	-	28 mm	lutowane	49,04 EUR	53,60 EUR	49,04 EUR	53,60 EUR	89,80 EUR
DBV.-035	1.3/8 "	35 mm	lutowane	68,64 EUR	73,36 EUR	68,64 EUR	73,36 EUR	125,20 EUR
DBV.-158	1.5/8 "	-	lutowane	87,36 EUR	92,08 EUR	87,36 EUR	92,08 EUR	-
DBV.-042	-	42 mm	lutowane	87,36 EUR	92,08 EUR	87,36 EUR	92,08 EUR	179,80 EUR
DBV.-054	2.1/8 "	54 mm	lutowane	120,40 EUR	125,20 EUR	120,40 EUR	125,20 EUR	287,20 EUR
DBV.-258	2.5/8 "	-	lutowane	189,04 EUR	193,76 EUR	189,04 EUR	193,76 EUR	-
DBV.-064-1	-	64 mm	lutowane	189,04 EUR	193,76 EUR	189,04 EUR	193,76 EUR	-
DBV.-064-2	-	64 mm	lutowane	271,12 EUR	276,00 EUR	271,12 EUR	276,00 EUR	-
DBV.-076	-	76 mm	lutowane	353,12 EUR	358,00 EUR	353,12 EUR	358,00 EUR	-
DBV.-089	-	89 mm	lutowane	449,52 EUR	454,32 EUR	449,52 EUR	454,32 EUR	-
DBV.-108	-	108 mm	lutowane	545,76 EUR	550,64 EUR	545,76 EUR	550,64 EUR	-

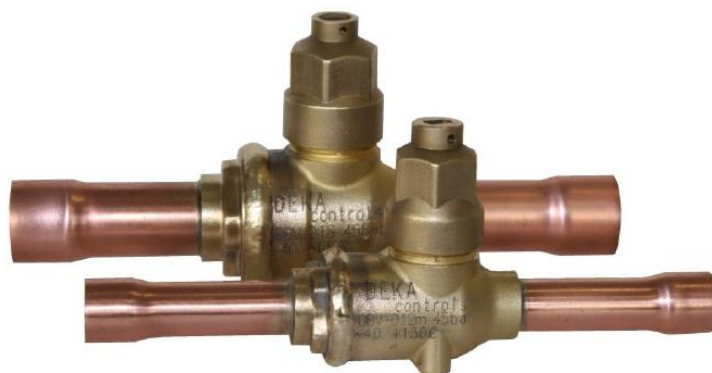



Przedsiębiorstwo Produkcyjno Handlowo Usługowe
ReBaNo
 Renata i Bartosz Nowaczy
 ul. Kopanina 39, 60-105 Poznań
 tel./faks: +48 61 657-93-65, e-mail: biuro@rebano.pl
 NIP: 779-103-65-86, REGON: 630603794
 Rok założenia 1996



DEKA
 controls

Niskociśnieniowy separator oleju serii TOH

Model	przyłącza		objętość odolejacza (l)	cena cennikowa HCFC, HFC - 31 bar
	wielkość	typ		
TOH-12A	-	12 mm	1,63	90,00 EUR
TOH-16A	5/8 "	16 mm	1,63	90,00 EUR
TOH-22A	7/8 "	22 mm	1,63	90,00 EUR
TOH-28B	1.1/8 "	28 mm	5,27	117,04 EUR
TOH-35B	1.3/8 "	35 mm	5,27	135,04 EUR
TOH-42B	1.5/8 "	42 mm	5,27	225,04 EUR
TOH-54B	2.1/8 "	54 mm	5,27	252,00 EUR

Wysokociśnieniowy separator oleju ze zbiornikiem oleju serii TOR

Model	przyłącza		pojemność zbiornika oleju (l)	cena cennikowa	
	wielkość	typ		46 bar HCFC, HFC, CO ₂	31 bar gazy palne HC (F1)
TOR 16-4	5/8 "	16 mm	4,00	234,00 EUR	257,44 EUR
TOR 22-4	7/8 "	22 mm	4,00	292,48 EUR	321,78 EUR
TOR 22-7	7/8 "	22 mm	7,00	315,92 EUR	347,52 EUR
TOR 28-4	1.1/8 "	28 mm	4,00	304,24 EUR	334,64 EUR
TOR 28-7	1.1/8 "	28 mm	7,00	339,28 EUR	373,20 EUR
TOR 35-4	1.3/8 "	35 mm	4,00	307,84 EUR	338,64 EUR
TOR 35-7	1.3/8 "	35 mm	7,00	355,52 EUR	390,96 EUR
TOR 35-12	1.3/8 "	35 mm	12,00	397,84 EUR	437,60 EUR
TOR 35-20	1.3/8 "	35 mm	20,00	444,64 EUR	489,12 EUR
TOR 42-7	1.5/8 "	42 mm	7,00	369,04 EUR	405,92 EUR
TOR 42-12	1.5/8 "	42 mm	12,00	416,72 EUR	458,40 EUR
TOR 42-20	1.5/8 "	42 mm	20,00	444,64 EUR	514,80 EUR
TOR 42-30	1.5/8 "	42 mm	30,00	561,60 EUR	617,78 EUR
TOR 54-12	2.1/8 "	54 mm	12,00	426,64 EUR	469,28 EUR
TOR 54-20	2.1/8 "	54 mm	20,00	491,44 EUR	540,56 EUR
TOR 54-30	2.1/8 "	54 mm	30,00	561,60 EUR	540,56 EUR
TOR 258-50	2.5/8 "	-	50,00	842,40 EUR	926,64 EUR
TOR 64-50	-	64 mm	50,00	842,40 EUR	926,64 EUR
TOR 80-50	-	80 mm	50,00	919,84 EUR	1 011,84 EUR



Wysokociśnieniowy separator oleju serii TOHH – 130 bar / CO₂

Model	przyłącza		objętość odolejacza (l)	cena cennikowa
	gaz wielkość / typ	olej		
TOHH 1/4"-1,5	1/4" NPT	rotalock	1,50	572,00 EUR
TOHH 1/2"-3,6	1/2" NPT	rotalock	3,60	1 984,00 EUR
TORH 3/4"-4,8	3/4" NPT	rotalock	4,80	2 184,00 EUR
TORH 1"-6,1	1" NPT	rotalock	6,10	2 976,00 EUR
TORH 1.1/4"-12	1.1/4" NPT	rotalock	12,00	3 244,00 EUR

Wysokociśnieniowy separator oleju ze zbiornikiem oleju serii TORH – 130 bar / CO₂

Model	przyłącza		pojemność zbiornika oleju (l)	cena cennikowa
	gaz wielkość / typ	olej		
TORH 1/2"-3	1/2 "	rotalock	3,00	234,00 EUR
TORH 1"-5	1 "	rotalock	5,00	292,48 EUR
TORH 1"-8	1 "	rotalock	8,00	304,24 EUR
TORH 1.1/4"-12	1.1/4 "	rotalock	12,00	315,92 EUR

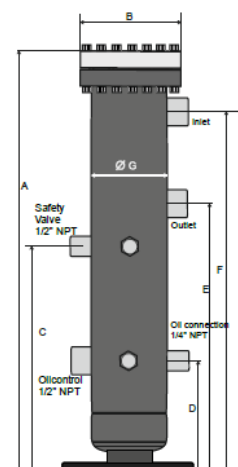



Przedsiębiorstwo Produkcyjno Handlowo Usługowe
ReBaNo
 Renata i Bartosz Nowaczy
 ul. Kopanina 39, 60-105 Poznań
 tel./faks: +48 61 657-93-65, e-mail: biuro@rebano.pl
 NIP: 779-103-65-86, REGON: 630603794
 Rok założenia 1996



DEKA
 controls

Zbiornik oleju serii DOR – 31 bar / HCFC, HFC, CO₂

Model	przyłącze-rotalock	wlot oleju	wylot oleju	zawór bezpieczeństwa	typ zbiornika	objętość (l)	cena cennikowa
DOR-7.5	1"-14 UNS	10 mm	12 mm	-	pionowy	7,5	155,04 EUR
DOR-11	1"-14 UNS	10 mm	16 mm	-	pionowy	11,0	178,96 EUR
DOR-18	1"-14 UNS	10 mm	16 mm	-	pionowy	18,0	258,72 EUR
DOR-32	1.1/4"-12 UNF	22 mm	22 mm	1/2" NPT	pionowy	32,0	351,36 EUR
DOR-L-30	1.1/4"-12 UNF	22 mm	22 mm	1/2" NPT	poziomy	30,0	304,08 EUR
DOR-L-35	1-1/4"-12 UNF	22 mm	22 mm	1/2" NPT	poziomy	35,0	344,16 EUR



Zbiornik oleju serii DORH – 130 bar / CO₂

Model	wlot oleju	wylot oleju	zawór bezpieczeństwa	typ zbiornika	objętość (l)	cena cennikowa
DORH-1/4"-3	1/4" NPT	1/4" NPT	1/2" NPT	pionowy	3,0	1 266,44 EUR
DORH-1/4"-5	1/4" NPT	1/4" NPT	1/2" NPT	pionowy	5,0	1 508,00 EUR
DORH-1/4"-7	1/4" NPT	1/4" NPT	1/2" NPT	pionowy	7,0	1 791,20 EUR
DORH-1/4"-10	1/4" NPT	1/4" NPT	1/2" NPT	pionowy	10,0	1 989,60 EUR
DORH-1/4"-12	1/4" NPT	1/4" NPT	1/2" NPT	pionowy	12,0	2 062,40 EUR

Zawór upustowy ciśnienia oleju w zbiorniku ORV – 45 bar / HCFC, HFC, CO₂

Model	Wlot / Wylot	różnica ciśnienia	cena cennikowa
ORV-015H	5/8"UNF	1,5 BAR	41,28 EUR
ORV-035H	5/8"UNF	3,5 BAR	41,28 EUR
ORV-050H	5/8"UNF	5,0 BAR	41,28 EUR



Filtry oleju – 46 bar / HCFC, HFC, CO₂ oraz HC (F1)

Model	przyłącze		cena cennikowa
	wielkość	typ	
DO-053	10 mm	skręcane	37,04 EUR
DO-053 F1	10 mm	skręcane	39,68 EUR
DO-053S	3/8 "	lutowane	37,04 EUR
DO-054	12 mm	skręcane	39,68 EUR
DO-054S	1/2 "	lutowane	37,04 EUR



Elektryczny regulator poziomu oleju serii COM1 lub COM2 zasilanie 230V/50hz lub 24V/50hz

Model	podłączenie do sprężarki	typ sprężarki	cena cennikowa	
			COM1-60 bar HFC, HC, CO ₂	COM2-120 bar CO ₂
COM.-230(24)	bez kabla i adaptera	-	221,64 EUR	232,28 EUR
COM.-230(24)/000	3 x 1.7/8" 4 x 50 mm	Bitzer, Bock, Bopeland, Dorin, Frascold	253,16 EUR	263,80 EUR
COM.-230(24)/034-14	3/4"-14 NPT	copeland	253,16 EUR	263,80 EUR
COM.-230(24)/114	rotalock 1.1/4"	Copeland	264,68 EUR	275,32 EUR
COM.-230(24)/118-18	1.1/8"-18 UNEF	Copeland, Frascold, Bitzer, Bock, Danfoss, Dorin	253,16 EUR	263,80 EUR
COM1-230(24)/134	rotalock 1-3/4"	Copeland	264,68 EUR	-
COM2-230(24)/D06	6 otworów	Dorin	-	275,32 EUR

Mechaniczny regulator poziomu oleju serii COR – 31 bar / HCFC, HFC

Model	podłączenie do sprężarki	ilość wzmerników	cena cennikowa
COR1	3 i 4 otwory	1 sztuka	112,00 EUR
COR2	3 i 4 otwory	2 sztuki	128,00 EUR
COR-AD-118-18	1.1/8"-18 UNEF	1 sztuka	128,00 EUR





Przedsiębiorstwo Produkcyjno Handlowo Usługowe

ReBaNo

Renata i Bartosz Nowaczy

ul. Kopanina 39, 60-105 Poznań

tel./faks: +48 61 657-93-65, e-mail: biuro@rebano.pl

NIP: 779-103-65-86, REGON: 630603794

Rok założenia 1996



DEKA
controls

Adaptory serii COM – 120 bar / HFC, HFO, HC, CO₂

Model	przyłącze	typ sprężarki	cena cennikowa
COM-AD-000	3 x 1.7/8" oraz 4 x 50 mm	HFC, HFO, CO₂ do 60 bar: BITZER: 4VC, 4TC, 4PC, 4NC, 4J, 4H, 4G, 6J, 6H, 6G, 6F, 8GC, 8FC, 4VHC-10K, 4THC-12K, 4PHC-15K, 4NHC-20K, 4VSL-15K...4NSL-30K, BITZER ecoline: 4VES-7Y...4NES-20Y, 4VE-7Y...4NE-20Y, 4JE-13Y...4FE-35Y BOCK: HA, HG, seria O, HGX4/310-4, 385-4, 464-4, 555-4 COPELAND: D2, D3, D4, D6, D9, 4CC, 6CC, ZBH, 4M, 6M DORIN: KP, K z wyłączeniem modeli pod COM-AD-118-18-DO, SCC 500B, 750B, 1500B, 1900B, 2000B, 2500B, H41, H5, H6, H7, SCC_1, SCC_32, SCC_4, CDSW_35, CDS_41 FRASCOLD: seria A, B, D, F, S, V, Z, seria A-SK, D-SK, F-SK, Q-SK, S-SK HC do 60 bar: BITZER ecoline: 4VESP-7Y...4NESP-20(Y), 4VEP-7Y...4NEP-20(Y), 4JEP-13Y...4FEP-35(Y) FRASCOLD: seria A, B, D, Q, S, V, Z, W	31,52 EUR
COM-AD-118-18	1.1/8"-18 UNEF	HFC, HFO, CO₂ do 60 bar: BITZER: 2KC, 2JC, 2HC, 2GC, 2FC, 2EC, 2DC, 2CC, 4FC, 4EC, 4DC, 4CC2KHC, 2JHC, 2HHC, 2GHC, 2FHC, 2EHC, 2DHC, 2CHC, 4FHC, 4EHC, 4DHC, 4CHC, 2MSL-07K...4CSL-12K BITZER ecoline: 2KES-05Y...2FES-3Y, 2EES-2Y...2CES-4Y, 4FES-3Y...4CES-9Y BOCK: HA12/22/34, HG12/22/34 HGX12P/40-4, 50-4, 60-4, 75-4, HGX22P110-4, HGX22P125-4, HGX22P160-4, HGX22P190-4, HGX34P/215-4, HGX34P/255-4 CO₂ do 120 bar: BITZER: 2MTE-4K...6CTE-50K BOCK: HGX34 CO ₂ T, HGX46 CO ₂ T COPELAND: 4MSL, 4MTL FRASCOLD: S8-8TK...S30-26TK HC do 60 bar: BITZER ecoline: 2KESP-05Y...2FESP-3Y, 2EESP-2Y...2CESP-4Y, 4FESP-3Y...4CESP-9Y	31,52 EUR
COM-AD-118-18-DA	1.1/8"-18 UNEF DANFOSS	HFC, HFO, CO₂ do 60 bar: DANFOSS: LFZ, MFZ, MLZ, MLM, MT, SM, SZ, LT L'unite Hermetique: FH, TFH, AG, TAG	31,52 EUR
COM-AD-118-18-DO	1.1/8"-18 UNEF DORIN	HFC, HFO, CO₂ do 60 bar: DORIN: H11, H2, H32, H35, K100CC/CS, K150CC/CS, K180CC/CS, K200CC, K230CS, K235CC, K240SB, K40CC, K50CS, K75CC/CS- SCC 250B, 300B, 350B, 380B, CDS_11	31,52 EUR
COM-AD-DO6	6 otworów DORIN	CO₂ do 120 bar: DORIN: CD200, CD300, CD400, CD2S-200, CD2S-400	31,52 EUR
COM-AD-012	1/2" NPT	zbiorniki ciekłego czynnika	31,52 EUR
COM-AD-034-14	3/4"-14 NPT	HFC, HFO, CO₂ do 60 bar: TRANE: seria K	31,52 EUR
COM-AD-114	rotalock 1-1/4"	HFC, HFO, CO₂ do 60 bar: COPELAND: ZB 15..ZB48, ZB50/58/66/76/95/114, ZF06..ZF25, ZS21..ZS45, ZO21, ZO34..ZO104	43,04 EUR
COM-AD-134	rotalock 1-3/4"	HFC, HFO, CO₂ do 60 bar: COPELAND: od 05.2012: ZB56..ZB11, ZS56..ZS11, ZF24..ZF48	43,04 EUR



Przedsiębiorstwo Produkcyjno Handlowo Usługowe

ReBaNo

Renata i Bartosz Nowaczy

ul. Kopanina 39, 60-105 Poznań

tel./faks: +48 61 657-93-65, e-mail: biuro@rebano.pl

NIP: 779-103-65-86, REGON: 630603794

Rok założenia 1996



DEKA
controls

Poziome zbiorniki ciekłego czynnika CFC, HCFC, HFC, HFO

Model	pojemność zbiornika	przyłącza zbiornika			wymiary zbiornika		ciśnienie	ilość wzierników	cena cennikowa
		wejście	wyjście	zawór bezpieczeństwa.	średnica	długość			
DLR-H7K	7,0 dm ³	1"-14 UNS	1"-14 UNS	1/2" NPT	ø 168 mm	530 mm	33,0 bar	1	94,28 EUR
DLR-H7KP	7,0 dm ³	1"-14 UNS	1"-14 UNS	1/2" NPT	ø 140 mm	530 mm	33,0 bar	1	134,72 EUR
DLR-H10K	10,0 dm ³	1"-14 UNS	1"-14 UNS	1/2" NPT	ø 168 mm	528 mm	33,0 bar	1	105,48 EUR
DLR-H10KP	10,0 dm ³	1"-14 UNS	1"-14 UNS	1/2" NPT	ø 168 mm	528 mm	33,0 bar	1	146,16 EUR
DLR-H15K	15,0 dm ³	1.1/4"-12 UNF	1"14 UNS	1/2" NPT	ø 168 mm	779 mm	33,0 bar	1	124,64 EUR
DLR-H15KP	15,0 dm ³	1.1/4"-12 UNF	1"14 UNS	1/2" NPT	ø 168 mm	779 mm	33,0 bar	1	165,36 EUR
DLR-H20K	20,0 dm ³	1.1/4"-12 UNF	1"14 UNS	1/2" NPT	ø 240 mm	615 mm	33,0 bar	2	180,56 EUR
DLR-H20KP	20,0 dm ³	1.1/4"-12 UNF	1-14 UNS	1/2" NPT	ø 219 mm	615 mm	33,0 bar	1	221,28 EUR
DLR-H25K	25,0 dm ³	1.1/4"-12 UNF	1.1/4"-12 UNF	1/2" NPT	ø 240 mm	760 mm	33,0 bar	2	201,36 EUR
DLR-H25KP	25,0 dm ³	1.1/4"-12 UNF	1.1/4"-12 UNF	1/2" NPT	ø 219 mm	760 mm	33,0 bar	1	242,24 EUR
DLR-H30	30,0 dm ³	1.1/4"-12 UNF	1.1/4"-12 UNF	1/2" NPT	ø 219 mm	905 mm	33,0 bar	2	271,68 EUR
DLR-H40	40,0 dm ³	1.3/4"-12 UN	1.1/4"-12 UNF	1/2" NPT	ø 273 mm	850 mm	33,0 bar	2	314,80 EUR
DLR-H50	50,0 dm ³	1.3/4"-12 UN	1.1/4"-12 UNF	1/2" NPT	ø 273 mm	1040 mm	33,0 bar	2	346,80 EUR
DLR-H70	70,0 dm ³	1.3/4"-12 UN	1.1/4"-12 UNF	1/2" NPT	ø 273 mm	1400 mm	33,0 bar	3	426,64 EUR
DLR-H90	90,0 dm ³	2.1/4"-12 UN	1.3/4"-12 UN	1/2" NPT	ø 323 mm	1300 mm	33,0 bar	3	578,48 EUR
DLR-H100	100,0 dm ³	2.1/4"-12 UN	1.3/4"-12 UN	1/2" NPT	ø 323 mm	1440 mm	33,0 bar	3	618,40 EUR
DLR-H130	130,0 dm ³	2.1/4"-12 UN	1.3/4"-12 UN	1/2" NPT	ø 323 mm	1851 mm	33,0 bar	3	730,32 EUR
DLR-H130B	130,0 dm ³	2.1/4"-12 UN	1.3/4"-12 UN	1/2" NPT	ø 400 mm	1191 mm	33,0 bar	3	1 134,56 EUR
DLR-H160	160,0 dm ³	2.1/4"-12 UN	1.3/4"-12 UN	1/2" NPT	ø 323 mm	2251 mm	33,0 bar	3	942,80 EUR
DLR-H160B	160,0 dm ³	2.1/4"-12 UN	1.3/4"-12 UN	1/2" NPT	ø 400 mm	1191 mm	33,0 bar	3	1 326,32 EUR

Pionowe zbiorniki ciekłego czynnika CFC, HCFC, HFC, HFO

Model	pojemność zbiornika	przyłącza zbiornika			wymiary zbiornika		ciśnienie	ilość wzierników	cena cennikowa
		wejście	wyjście	zawór bezpieczeństwa.	średnica	długość			
DLR-V1K	1,0 dm ³	1"14 UNS	1"-14 UNS	BRAK	ø 101 mm	162 mm	33,0 bar	BRAK	39,00 EUR
DLR-V1,5K	1,5 dm ³	1"-14 UNS	1"-14 UNS	BRAK	ø 101 mm	226 mm	33,0 bar	BRAK	38,36 EUR
DLR-V2K	2,0 dm ³	1"-14 UNS	1"-14 UNS	BRAK	ø 125 mm	205 mm	33,0 bar	1	54,32 EUR
DLR-V3K	3,0 dm ³	1"-14 UNS	1"-14 UNS	BRAK	ø 125 mm	290 mm	33,0 bar	1	89,52 EUR
DLR-V4K	4,0 dm ³	1"-14 UNS	1"-14 UNS	BRAK	ø 152 mm	270 mm	33,0 bar	1	95,92 EUR
DLR-V6K	6,0 dm ³	1"-14 UNS	1"-14 UNS	BRAK	ø 168 mm	285 mm	33,0 bar	1	94,28 EUR
DLR-V8K	8,0 dm ³	1"-14 UNS	1"-14 UNS	BRAK	ø 195 mm	310 mm	33,0 bar	1	120,64 EUR
DLR-V10K	10,0 dm ³	1"-14 UNS	1"-14 UNS	BRAK	ø 219 mm	335 mm	33,0 bar	1	129,44 EUR
DLR-V12,5K	12,5 dm ³	1.1/4"-12 UNF	1"-14 UNS	1/2" NPT	ø 219 mm	404 mm	33,0 bar	1	135,84 EUR
DLR-V15K	15,0 dm ³	1.1/4"-12 UNF	1.1/4"-12 UNF	1/2" NPT	ø 250 mm	371 mm	33,0 bar	1	155,04 EUR
DLR-V20K	20,0 dm ³	1.1/4"-12 UNF	1.1/4"-12 UNF	1/2" NPT	ø 250 mm	435 mm	33,0 bar	1	164,56 EUR
DLR-V25K	25,0 dm ³	1.1/4"-12 UNF	1.1/4"-12 UNF	1/2" NPT	ø 219 mm	764 mm	33,0 bar	1	223,76 EUR
DLR-V30K	30,0 dm ³	1.3/4"-12 UN	1.1/4"-12 UNF	1/2" NPT	ø 273 mm	612 mm	33,0 bar	2	239,68 EUR
DLR-V30	30,0 dm ³	1.1/4"-12 UNF	1.1/4"-12 UNF	1/2" NPT	ø 273 mm	612 mm	33,0 bar	2	322,80 EUR
DLR-V40	40,0 dm ³	1.3/4"-12 UN	1.1/4"-12 UNF	1/2" NPT	ø 273 mm	850 mm	33,0 bar	2	362,72 EUR
DLR-V50	50,0 dm ³	1.3/4"-12 UN	1.1/4"-12 UNF	1/2" NPT	ø 273 mm	1040 mm	33,0 bar	2	399,52 EUR
DLR-V60	60,0 dm ³	1.3/4"-12 UN	1.1/4"-12 UNF	1/2" NPT	ø 273 mm	1165 mm	33,0 bar	2	434,64 EUR
DLR-V70	70,0 dm ³	1.3/4"-12 UN	1.1/4"-12 UNF	1/2" NPT	ø 273 mm	1400 mm	33,0 bar	2	474,64 EUR
DLR-V90	90,0 dm ³	2.1/4"-12 UN	1.3/4"-12 UN	1/2" NPT	ø 323 mm	1300 mm	33,0 bar	3	594,48 EUR
DLR-V100	100,0 dm ³	2.1/4"-12 UN	1.3/4"-12 UN	1/2" NPT	ø 323 mm	1440 mm	33,0 bar	3	634,40 EUR
DLR-V130	130,0 dm ³	2.1/4"-12 UN	1.3/4"-12 UN	1/2" NPT	ø 323 mm	1851 mm	33,0 bar	3	746,24 EUR
DLR-V130B	130,0 dm ³	2.1/4"-12 UN	1.3/4"-12 UN	1/2" NPT	ø 400 mm	1191 mm	33,0 bar	3	958,80 EUR
DLR-V160	160,0 dm ³	2.1/4"-12 UN	1.3/4"-12 UN	1/2" NPT	ø 323 mm	2251 mm	33,0 bar	3	1 081,84 EUR
DLR-V160B	160,0 dm ³	2.1/4"-12 UN	1.3/4"-12 UN	1/2" NPT	ø 400 mm	1434 mm	33,0 bar	3	1 342,32 EUR



Przedsiębiorstwo Produkcyjno Handlowo Usługowe
ReBaNo
 Renata i Bartosz Nowaczy
 ul. Kopanina 39, 60-105 Poznań
 tel./faks: +48 61 657-93-65, e-mail: biuro@rebano.pl
 NIP: 779-103-65-86, REGON: 630603794
 Rok założenia 1996



DEKA
 controls

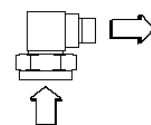
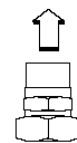
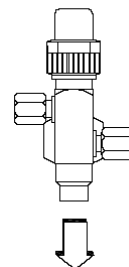
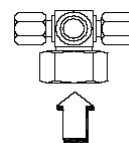
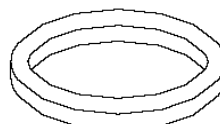

Zawory rotalock i uszczelki teflonowe

model	gwint	przyłącze lutowane	cena cennikowa
TRR-34-10	3/4 "	10 mm	7,20 EUR
TRR-1-10	1 "	10 mm	14,80 EUR
TRR-1-038	1 "	3/8"	14,80 EUR
TRR-1-12	1 "	12 mm	14,80 EUR
TRR-1-012	1 "	1/2"	14,80 EUR
TRR-1-16	1 "	16 mm – 5/8"	14,80 EUR
TRR-114-16	1.1/4 "	16 mm – 5/8"	25,60 EUR
TRR-114-22	1.1/4 "	22 mm – 7/8"	25,60 EUR
TRR-114-28	1.1/4 "	28 mm	25,60 EUR
TRR-134-22	1.3/4 "	22 mm – 7/8"	41,52 EUR
TRR-134-28	1.3/4 "	28 mm	41,52 EUR
TRR-134-35	1.3/4 "	35 mm – 1.3/8"	41,52 EUR
TRR-134-42	1.3/4 "	42 mm	41,52 EUR
TRR-214-42	2.1/4 "	42 mm	99,04 EUR
TRR-214-54	2.1/4 "	54 mm	99,04 EUR

model	wielkość uszczelki	cena cennikowa
TEFLON 3/4"	3/4"	0,50 EUR
TEFLON 1"	1"	0,70 EUR
TEFLON 1.1/4"	1.1/4"	0,90 EUR
TEFLON 1.3/4"	1.3/4"	1,10 EUR
TEFLON 2.1/4"	2.1/4"	1,30 EUR

Redukcja rotalock – przyłącze lutowane

Model	przyłącze redukcja kątowna		cena cennikowa
	rotalock	lutowane	
TAW-34-10	3/4"-16 UNF	10 mm	8,80 EUR
TAW-34-6	3/4"-16 UNF	6 mm	8,80 EUR
TAW-114-16	1.1/4"-12 UNF	16 mm	16,80 EUR
TAW-114-22	1.1/4"-12 UNF	22 mm	16,80 EUR
TAW-134-22	1.3/4"-12 UN	22 mm	26,40 EUR
TAW-134-28	1.3/4"-12 UN	28 mm	26,40 EUR
TAW-134-35	1.3/4"-12 UN	35 mm	29,60 EUR
TAW-134-42	1.3/4"-12 UN	42 mm	29,60 EUR
TAW-214-42	2.1/4"-12 UN	42 mm	35,92 EUR
TAW-214-54	2.1/4"-12 UN	54 mm	39,12 EUR

Model	przyłącze redukcja prosta		cena cennikowa
	rotalock	lutowane	
TAG-34-6	3/4"-16 UNF	6 mm	7,20 EUR
TAG-34-10	3/4"-16 UNF	10 mm	7,20 EUR
TAG-114-16	1.1/4"-12 UNF	16 mm	12,00 EUR
TAG-114-22	1.1/4"-12 UNF	22 mm	12,00 EUR
TAG-134-22	1.3/4"-12 UN	22 mm	15,20 EUR
TAG-134-28	1.3/4"-12 UN	28 mm	15,20 EUR
TAG-134-35	1.3/4"-12 UN	35 mm	15,20 EUR
TAG-134-42	1.3/4"-12 UN	42 mm	15,20 EUR
TAG-214-42	2.1/4"-12 UN	42 mm	23,20 EUR
TAG-214-54	2.1/4"-12 UN	54 mm	29,60 EUR

Elektroniczny czujnik niskiego i wysokiego poziomu cieczy serii COML / COMH

Model	zasilanie	maksymalne ciśnienie robocze	czynnik chłodniczy	cena cennikowa
COML-24	24 V	60 BAR	HFC, HFO, CO ₂	122,40 EUR
COML-230	230 V	60 BAR	HFC, HFO, CO ₂	124,00 EUR
COMH-24	24 V	120 BAR	HFC, HFO, CO ₂	132,00 EUR
COMH-230	230 V	120 BAR	HFC, HFO, CO ₂	136,00 EUR



Adaptery do czujników poziomu czynnika na stronie M 6.